



iLOQ S50  
P55S Programming Key  
User Guide



09/2024  
Rev 1.5

Document ID  
239669



**iLOQ Oy**  
[support.iloq.com](https://support.iloq.com)

# 1. Contents



1.	Contents .....	2
2.	Safety Information.....	3
2.1	Safety signs .....	3
2.2	Warnings.....	3
3.	Products .....	4
4.	Care and Maintenance .....	4
5.	Before use.....	4
6.	Operating instructions of the P55S Programming Key.....	5
6.1	Connecting the P55S Programming Key to the A00.18 Desktop Programming Adapter.....	5
6.2	Programming with the A00.18 Desktop Programming Adapter connected to a PC.....	5
6.3	Programming without an A00.18 Desktop Programming Adapter .....	6
6.4	Programming offline (without a PC connection) .....	8
6.5	LED functions of the P55S Programming Key .....	8
6.6	Charging the P55S Programming Key .....	9
6.7	Battery charging specifications .....	9
7.	Accessories.....	10
8.	Disposal of Decommissioned Products .....	11
9.	Compliance .....	12

## 2. Safety Information

### 2.1 Safety signs

Sign	Description
	General notice sign. Indicates particularly important information about the installation and deployment.
	Read these instructions carefully before using products. This information is to ensure your safety and the long lifetime of the products.

### 2.2 Warnings

Sign	Description
	Warning! K55S / P55S contains a non-replaceable rechargeable battery. Disposal of a battery into fire or a hot oven, or mechanically crushing or cutting of a battery can result in an explosion.
	Warning! Leaving a battery in an extremely high temperature environment can result in an explosion or the leakage of flammable liquid or gas.
	Warning! A battery subjected to extremely low air pressure may result in an explosion or the leakage of flammable liquid or gas.

### 3. Products

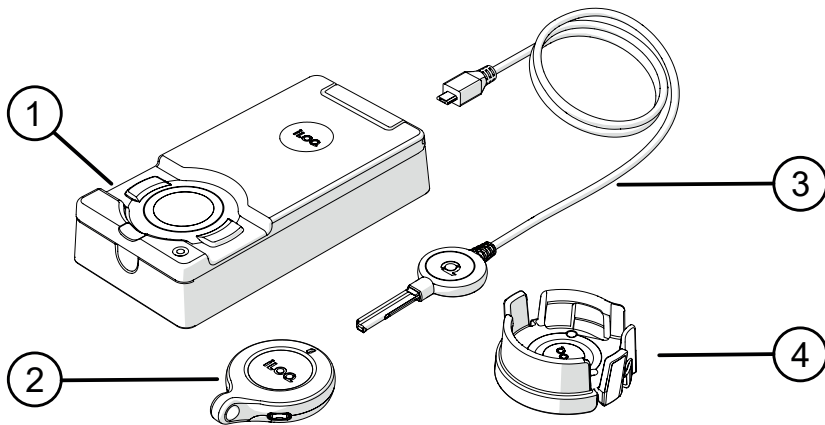

1. iLOQ A00.18 Desktop Programming Adapter
2. iLOQ P55S Programming Key
3. iLOQ A00.17 Programming Cable
4. iLOQ A00.20 Handheld Programming Adapter

### 4. Care and Maintenance

- The product is designed to be maintenance-free. It does not require any regular maintenance.
- Do not use the P55S Programming Key for other purposes except those mentioned in these instructions.
- Using the P55S Programming Key for other purposes may damage it.
- The P55S Programming Key is to be kept secure so that only an authorized person can use it.
- In case of losing the P55S Programming Key, contact the administrator of the locking system.
- Maximum temperature range for use: -20 - +55C
- Maximum temperature range for charging: +10 - +45C
- Ingress protection rating: IP57. Keep the P55S Programming Key clean and dry. If the P55S Programming Key is wet or dirty, use a soft cloth for drying and cleaning.
- For more detailed technical information, see the P55S Programming Key datasheet.
- The P55S Programming Key is an electronic product including a Lithium-Ion rechargeable battery. Appropriate recycling as WEEE waste must be followed.
- For customer claims, technical support etc., please contact your administrator. Your administrator will contact the appropriate iLOQ partner for support.
- Recharge the P55S Programming Key if operation is abnormal. During charging, the P55S Programming Key resets. If abnormal operation continues, contact locking system administrator.



### 5. Before use

To ensure correct operation, charge the P55S Programming Key before first use.

## 6. Operating instructions of the P55S Programming Key

The P55S Programming Key is used with the iLOQ Manager software. All programming tasks are prepared in the Manager and then transferred to the P55S Programming Key via USB.

### 6.1 Connecting the P55S Programming Key to the A00.18 Desktop Programming Adapter

The A00.18 Desktop Programming Adapter allows a PC and an A00.17 Programming Cable to be connected to the P55S Programming Key at the same time. This way you can transfer programming tasks to the memory of the P55S Programming Key and also use the A00.17 Programming Cable without having to swap cables.

1. Connect the P55S Programming Key to the custom USB cable inside the adapter.  
Note: This cable is a custom-made cable and cannot be replaced with a standard USB Micro-B cable, if broken.

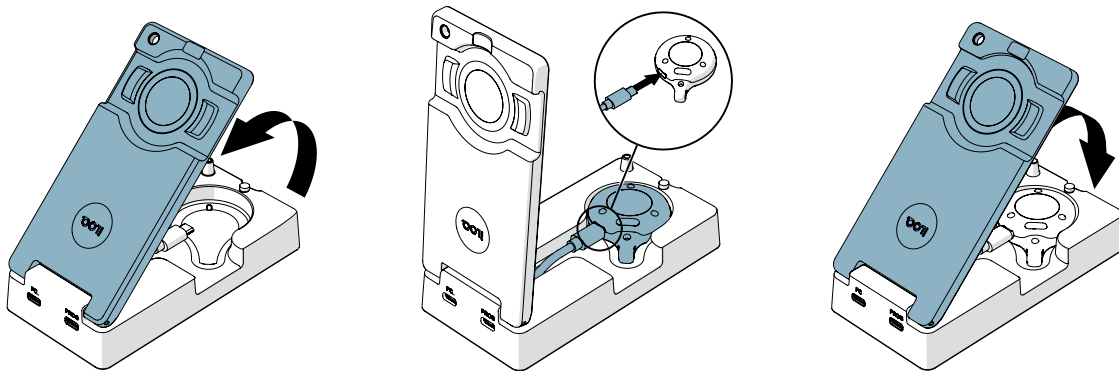

### 6.2 Programming with the A00.18 Desktop Programming Adapter connected to a PC

1. Connect a computer to the adapter PC port with a standard USB Micro-B cable.

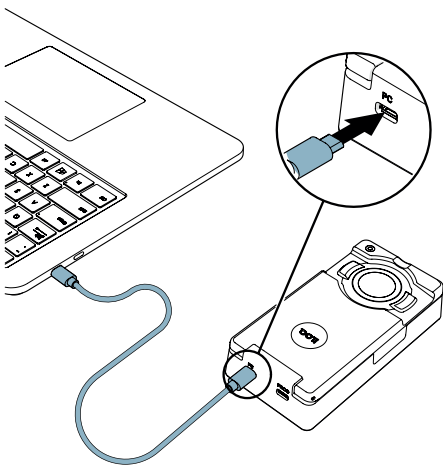

2. If you need to program key operated locks, connect the A00.17 Programming cable to the adapter PROG port.

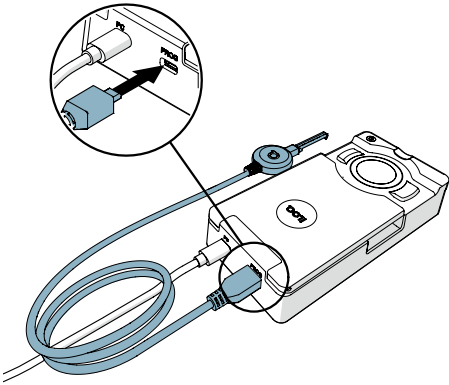

3. Execute the programming tasks from the iLOQ Manager to transfer them to the P55S Programming Key.
4. When programming K5S Key operated locks, use the A00.17 Programming cable. When programming other iLOQ products, use the programming area of the A00.18 Programming Adapter.

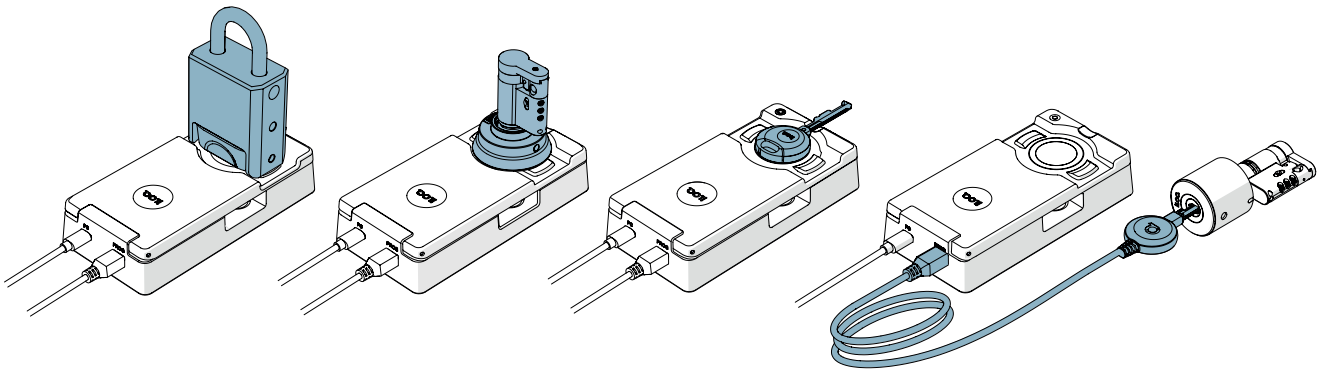

### 6.3 Programming without an A00.18 Desktop Programming Adapter

1. Connect the P55S Programming Key directly to the USB port of a PC with a standard USB Micro-B cable.

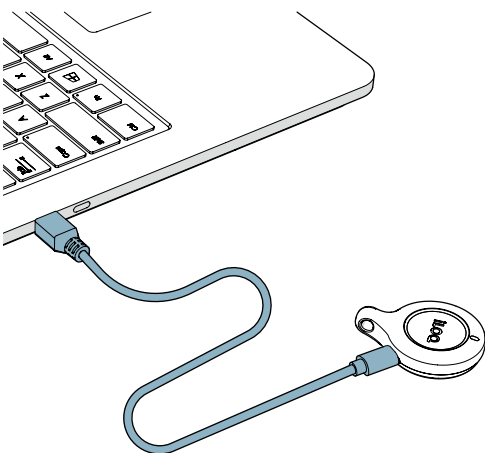

2. Execute the programming tasks from the iLOQ Manager to transfer them to the P55S Programming Key.
3. Place the P55S Programming Key on the product you intend to program while the PC is connected. For best performance, touch the reader antenna or K5S key bow with the bottom of the P55S Programming Key as shown in the following illustration.

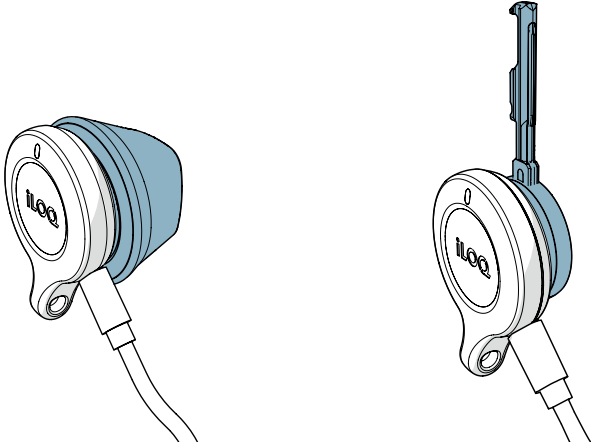

## 6.4 Programming offline (without a PC connection)

After transferring the tasks to the P55S Programming Key, disconnect the P55S Programming Key from the computer and program the intended locks and keys on-site. To program key operated locks, you need the A00.17 Adapter Cable.

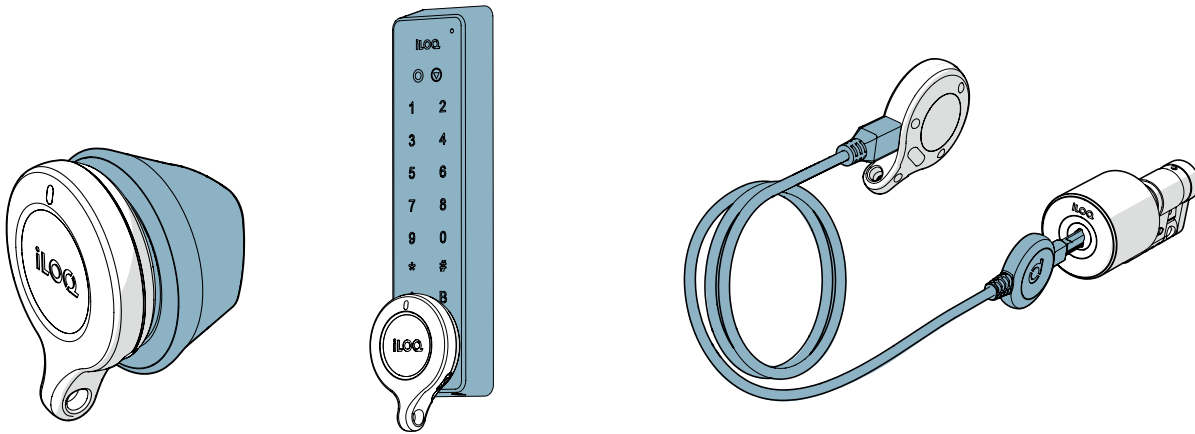

## 6.5 LED functions of the P55S Programming Key



Light indicators	Description
• Amber light while programming	• Programming Key communicating
• Green light after amber	• Programming completed
• Red light after amber	• Programming failed
• Red blinks, 0,1 sec once a minute	• Battery empty. Charge the battery.
• Amber blinks, 1 sec once a minute	• Battery low. Charge the battery.



## 6.6 Charging the P55S Programming Key

To charge the P55S Programming Key, use the USB Micro-B connector.

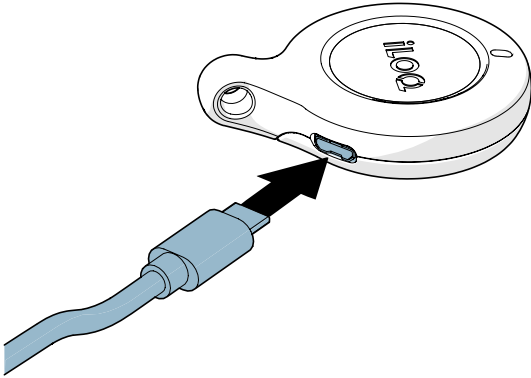

## 6.7 Battery charging specifications

Unit	Value
• Voltage	• 5 V
• Current	• 100 mA
• Charging time	• 3 hours
• Capacity	• 150 mAh

Light indicator	Meaning
• Solid red light	• Battery charging
• Solid green light	• Battery fully charged

## 7. Accessories

- The A00.20 Handheld Programming Adapter can be used to help hold a P55S Programming Key on round readers during programming.

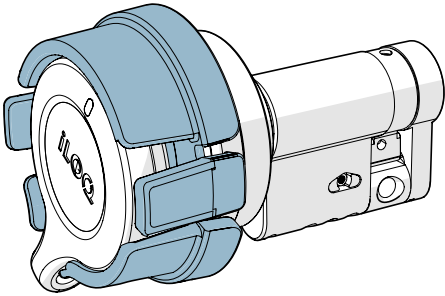

- The AK50.1-AK50.9 Color Markers can be used to personalize P55S Programming Keys. To replace the Color Marker, remove the old one with a suitable tool and replace it with a new one.

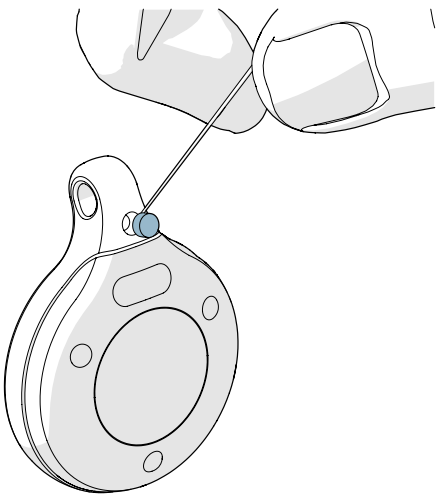

## 8. Disposal of Decommissioned Products

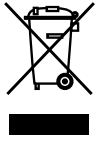





Never discard an electrical appliance in household waste. Follow the local laws and regulations for safe and environmentally friendly product disposal.



Before discarding products, bear in mind that most iLOQ products are **reusable**. All programmable products can be reset to factory settings, after which they can be reused in another system or an entirely new system.

Recycling instructions of decommissioned products are depicted below.

Decommissioned product	Sorting
Decommissioned iLOQ fittings, mounting accessories and thumb turn knobs can be recycled as scrap metal.	
Decommissioned iLOQ products containing electronics and circuit boards, such as iLOQ Lock Cylinders, keys, net bridges, door modules, key and RFID readers, and relay cards, must be recycled at an electrical and electronic equipment collection point.	
iLOQ products containing batteries and accumulators, such as key fobs, programming keys and clock circuits, should be recycled at a regional collection point for batteries and small accumulators.	
Most iLOQ packaging materials are suitable for cardboard and plastic recycling.	

## 9. Compliance

The products mentioned inside this user guide are in conformity with the requirements of the directives declared on this page.

### CE

#### **SIMPLIFIED EU DECLARATION OF CONFORMITY:**

Hereby, iLOQ Oy declares that the radio equipment type P55S Programming Keys are in compliance with Directive 2014/53/EU. The full text of the EU declaration of conformity is available at the following internet address: [www.iloq.com/en/declaration-of-compliance/](http://www.iloq.com/en/declaration-of-compliance/)

Communication standard: NFC 13,56 MHz Load modulation (ASK) ISO/IEC 14443A, no transmitter.

### FCC

This device contains licence-exempt transmitter(s)/receiver(s) that comply with Innovation, Science and Economic Development Canada's licence-exempt RSS(s) and complies with part 15 of the FCC Rules. Operation is subject to the following two conditions:

1. This device may not cause harmful interference.
2. This device must accept any interference received, including interference that may cause undesired operation of the device.

L'émetteur/récepteur exempt de licence contenu dans le présent appareil est conforme aux CNR d'Innovation, Sciences et Développement économique Canada applicables aux appareils radio exempts de licence. L'exploitation est autorisée aux deux conditions suivantes :

1. L'appareil ne doit pas produire de brouillage;
2. L'appareil doit accepter tout brouillage radioélectrique subi, même si le brouillage est susceptible d'en compromettre le fonctionnement.

**Note:** This equipment has been tested and found to comply with the limits for a Class B digital device, pursuant to part 15 of the FCC Rules. These limits are designed to provide reasonable protection against harmful interference in a residential installation. This equipment generates, uses and can radiate radio frequency energy and, if not installed and used in accordance with the instructions, may cause harmful interference to radio communications. However, there is no guarantee that interference will not occur in a particular installation. If this equipment does cause harmful interference to radio or television reception, which can be determined by turning the equipment off and on, the user is encouraged to try to correct the interference by one or more of the following measures:

- Reorient or relocate the receiving antenna.
- Increase the separation between the equipment and receiver.
- Connect the equipment into an outlet on a circuit different from that to which the receiver is connected.
- Consult the dealer or an experienced radio/TV technician for help.

Changes or modifications made to this equipment not expressly approved by iLOQ Oy may void the FCC authorization to operate this equipment.

System	Frequency	Maximum SAR
• NFC	• 13.56 MHz	• 0.03 W/kg (SAR1g)

## UKCA

Hereby, iLOQ Oy declares that the radio equipment type P55S Programming Keys are in compliance with the UK relevant statutory requirements. The full text of the declaration of conformity is available at the following internet address: [www.iloq.com/en/declaration-of-compliance/](http://www.iloq.com/en/declaration-of-compliance/)

## Battery

Contains battery 175-8405, imported to EU by iLOQ Oy.

iLOQ Oy

Elektroniikkatie 10

FI-90590 Oulu

[www.iloq.com](http://www.iloq.com)

### Rechargeable Li-ion Battery

175-8405 (1CP5/21/28)

3.7V 150mAh 0.56Wh

Caution: Do not short circuit.

Manufactured by

Celltech (Zhongshan) Ltd.



240100001



Manufacturer of battery

Celltech (Zhongshan) Ltd.

4th Floor, Building 3 No. 6 Jiusha Road, Torch Development District

Zhongshan, China

Mobile: +86 13392596397

Email: [CustomerService@celltechzhongshan.com](mailto:CustomerService@celltechzhongshan.com)

Web: [www.celltech-group.com](http://www.celltech-group.com)



iLOQ S50  
P55S Programming Key  
User Guide

**iLOQ**

[support.ilq.com](https://support.ilq.com)

Elektroniikkatie 10

90590 Oulu

Finland