



Life made limitless.

## D50S.711A.SD.55 Europrofile anti-panic cylinder

---

### System-level description

The patented, award winning iLOQ S50 locking system offers advanced security and convenient access sharing features for master-key locking environments.

The iLOQ D50S Europrofile cylinders harvest electricity wirelessly from the NFC field. This technology transforms a smartphone into a key and power source making the lock completely battery-free. Because no batteries are required, the locks are a maintenance-free and environmentally-friendly green solution that reduces workload, costs, waste and harm associated with battery-powered solutions.

The iLOQ S50 doesn't have a keyway due to contactless NFC technology. The lock is designed for exposure to harsh environments and extreme climates, while remaining water-resistant and dustproof.

The smartphone as a key provides exceptional features coupled with high security. With flexible access sharing, time restrictions and audit trail reporting over-the-air, security gaps caused by lost keys can be eliminated completely without costly changes to locks and keys.

---

### Feature summary

- battery-free programmable electromechanical lock cylinder for iLOQ S50 locking system
- NFC-powered: no batteries required for the lock
- Opening with NFC enabled Android or iOS phone or iLOQ K55S Key Fob
- Secured using powerful AES-256 encryption and mutual authentication
- Compatible with EN 15684 / DIN 18252 Europrofile cylinder standard
- Lengths available in 5 mm steps up to 100 mm (knob side)
- Initial programming with PC and iLOQ P55S.1 Programming Token in connection to server
- Access right list for access groups
- Blocklist for individual lost keys
- Internal audit trail record with time stamp (can be configured on/off)
- Supports time restrictions
- Can be configured to require online opening authentication
- Re-programming with keys (Android/iOS phone or K55S Key Fob)
- Firmware updateable

## Dimensional drawing

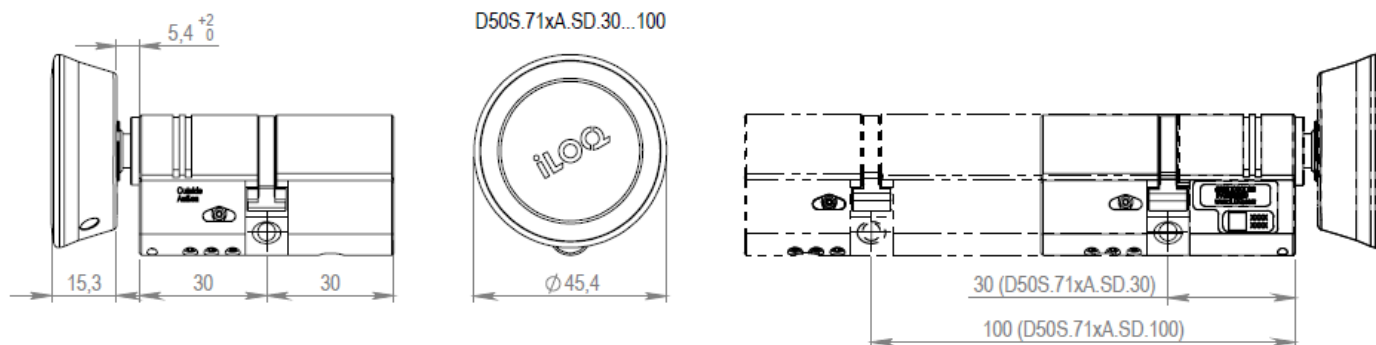

## Memory capacity

Number of access rights.....	210
Number of blocklisted keys.....	500
Number of time slots.....	10
Size of event log.....	500

## Technical data

Ingress protection rating.....	IP55
Reader type.....	Short reader
Surface treatment.....	Satin chrome

## Certificates

Attack resistance (EN 15684:2020).....	Grade D
Category of use (EN 15684:2020).....	Grade 1
Credential related security (EN 15684:2020).....	Grade D
Durability (EN 15684:2020).....	Grade 6
Environmental resistance (EN 15684:2020).....	Grade 4
Fire/smoke resistance (EN 15684:2020).....	Grade B
Mechanical key related security (EN 15684:2020).....	Grade 0
System management (EN 15684:2020).....	Grade 3
Other certificates.....	FCC, ISED