

H10S5.2.50.HC Padlock

System-level description

The patented, award winning iLOQ S10 locking system offers advanced security and convenient access management for master-key locking environments.

The iLOQ S10 padlocks enable usage of the iLOQ S10 locking system for securing remote objects and locations. The self-powered iLOQ padlocks are available in different body and shackle sizes. The iLOQ padlock records audit trail of the key usages and enables flexible access management for each key and each padlock. The security level is kept high and security gaps caused by lost key can be eliminated completely without costly change of locks and keys.

The product should not be modified in any way except in accordance with those modifications described in the instructions.

Feature summary

- Programmable electromechanic padlock for iLOQ S10 locking system
- Self-powered: no batteries or external energy source required for the lock and key
- All iLOQ S10 padlocks and iLOQ S10 keys are mechanically identical
- Secured using powerful encryption methods; unique 64bit challenge and SHA-1 computed 160bit MAC pair for key authentication
- Programmed using a PC and the iLOQ P10S.10 Programming device
- Blocklist for individual lost keys
- Access group list for key accesses
- Pre-blocklisting of lost key using a replacing key
- Firmware updateable

Dimensional drawing

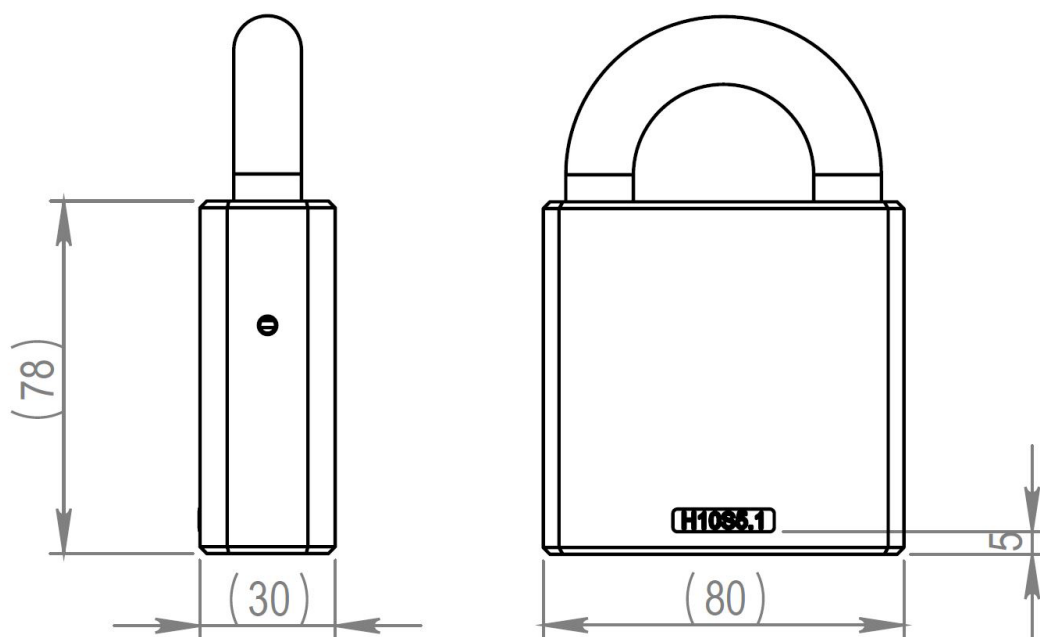

Memory capacity

Number of access rights	210
Number of blocklisted keys	256
Number of time limitations	2
Number of access rights with version-data	1+208
Size of event log	512

Technical data

Chain included	X
Ingress protection rating	IP21
Security grade	Grade 5
Real time clock battery lifetime	10 years
Real time clock compatibility	One real time clock included
Remote management with iLOQ Online products	X
Surface treatment	Polished chrome
Maximum temperature	70°C
Maximum temperature	176°F
Minimum temperature	-25°C
Minimum temperature	-40°F
Usage environment	Outdoor

Certificates

Category of use (EN 15684:2013-01)	Class 1
Durability (EN 15684:2013-01)	Grade 6
Electronic key related security (EN 15684:2013-01)	Class F
Environmental resistance (EN 15684:2013-01)	Class 4
Fire/smoke resistance (EN 15684:2013-01)	Class 0
Mechanical key related security (EN 15684:2013-01)	Grade A
System management (EN 15684:2013-01)	Grade 3
Attack resistance (EN 16864:2017)	Class 5
Category of use (EN 16864:2017)	Class 1
Corrosion resistance (EN 16864:2017)	Class 3
Durability (EN 16864:2017)	Class 1