



Life made limitless.

D50S.711.SD.75 Europrofile anti-panic cylinder

System-level description

The patented, award winning iLOQ S50 locking system offers advanced security and convenient access sharing features for master-key locking environments.

The iLOQ D50S Europrofile cylinders harvest electricity wirelessly from the NFC field. This technology transforms a smartphone into a key and power source making the lock completely battery-free. Because no batteries are required, the locks are a maintenance-free and environmentally-friendly green solution that reduces workload, costs, waste and harm associated with battery-powered solutions.

The iLOQ S50 doesn't have a keyway due to contactless NFC technology. The lock is designed for exposure to harsh environments and extreme climates, while remaining water-resistant and dustproof.

The smartphone as a key provides exceptional features coupled with high security. With flexible access sharing, time restrictions and audit trail reporting over-the-air, security gaps caused by lost keys can be eliminated completely without costly changes to locks and keys.

Feature summary

- battery-free programmable electromechanical lock cylinder for iLOQ S50 locking system
- NFC-powered: no batteries required for the lock
- Opening with NFC enabled Android or iOS phone or iLOQ K55S Key Fob
- Secured using powerful AES-256 encryption and mutual authentication
- Compatible with EN 15684 / DIN 18252 Europrofile cylinder standard
- Lengths available in 5 mm steps up to 100 mm (knob side)
- Initial programming with PC and iLOQ P55S.1 Programming Token in connection to server
- Access right list for access groups
- Blocklist for individual lost keys
- Internal audit trail record with time stamp (can be configured on/off)
- Supports time restrictions
- Can be configured to require online opening authentication
- Re-programming with keys (Android/iOS phone or K55S Key Fob)
- Firmware updateable

Dimensional drawing

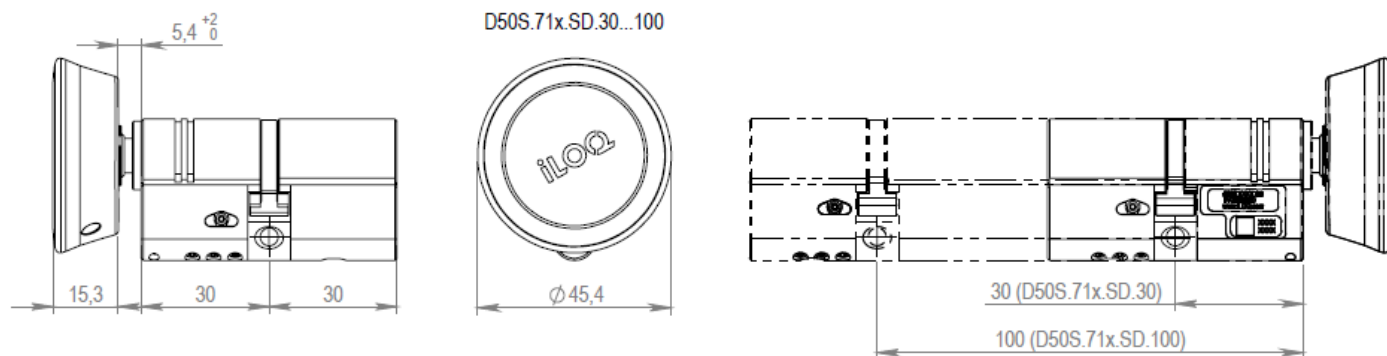

Memory capacity

Number of access rights	210
Number of blocklisted keys	500
Number of time slots	10
Size of event log	500

Technical data

Ingress protection rating	IP55
Reader type	Short reader
Surface treatment	Satin chrome

Certificates

Attack resistance (EN 15684:2020)	Grade 0
Category of use (EN 15684:2020)	Grade 1
Credential related security (EN 15684:2020)	Grade D
Durability (EN 15684:2020)	Grade 6
Environmental resistance (EN 15684:2020)	Grade 4
Fire/smoke resistance (EN 15684:2020)	Grade B
Mechanical key related security (EN 15684:2020)	Grade 0
System management (EN 15684:2020)	Grade 3
Other certificates	FCC, ISED