

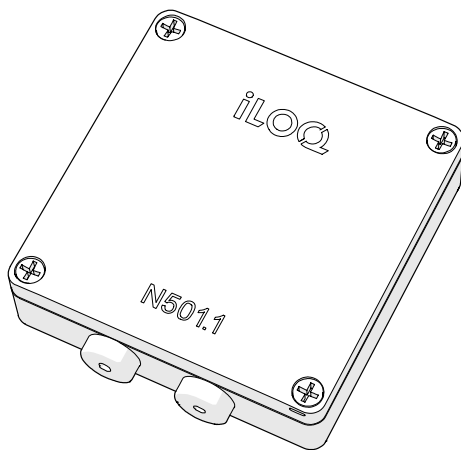

iLOQ 5 Series

iLOQ N501.1 Standalone Door Module

Installation and deployment



02/2025
Rev. 1.0

Document ID
319330





iLOQ Oy
support.iloq.com

Contents

1.	Safety information.....	3
1.1	Safety signs	3
1.2	General warnings.....	4
2.	Important	5
2.1	This document	5
2.2	Before installation.....	5
2.3	Licenses	5
2.4	iLOQ N501.1 Standalone Door Module modem type	6
3.	Installation of the devices.....	7
3.1	Device dimensions	7
3.2	Overview of the iLOQ N501.1 Standalone Door Module	7
3.3	Installing the iLOQ N501.1 Standalone Door Module	8
4.	Wiring the system	9
4.1	N501.1 Connection points and additional information.....	9
4.2	Example of wiring for the iLOQ N501.1 Standalone Door Module	10
5.	Deployment.....	11
5.1	Setup.....	11
5.2	Adding a network module to the iLOQ Manager	13
5.3	Programming	13
6.	iLOQ Manager	16
6.1	Editing the settings of a Network Module (Net Bridge)	16
6.2	Editing the settings of an iLOQ N501.1 Lock (Door Module).....	16
6.3	Typical things to look at in the iLOQ Manager	17
6.4	Updates	18
6.5	Typical cases in the field.....	19
7.	LED functions on the iLOQ NFC Reader	20
8.	Replacement and disposal.....	21
8.1	Disposal of decommissioned products	21
9.	Compliance	22

1. Safety information

1.1 Safety signs

Sign	Description
	Electrical hazard. Indicates the presence of a hazard which could result in personal injury. Before working on any equipment, be aware of the hazards involved with electrical circuitry, and get familiar with standard practices for preventing accidents.
	General warning sign. Indicates the presence of a hazard which could result in personal injury, equipment damage, or loss of data.
	General notice sign. Indicates particularly important information about the installation and deployment.
	Read these instructions carefully before installation. This information is to ensure your safety and the long lifetime of the products installed.
	Use protective gloves.

1.2 General warnings

	<p>Make sure that the power supply to the installation site is disconnected during installation. Do not switch on the power supply until the installation is complete.</p>
	<p>iLOQ devices must be installed and used effortlessly without the use of excessive force.</p>
	<p>Products should not be modified in any way except in accordance with the modifications described in these instructions.</p>
	<p>Installation should only be performed by a qualified technician.</p>
	<p>Use protective gloves during installation to avoid personal injury.</p>

2. Important

2.1 This document

This document contains installation and deployment instructions for the iLOQ N501.1 Standalone Door Module. The iLOQ N501.1 Standalone Door Module is a standalone door module that is installed near a door and connected to the server with a 4G connection. The door module controls the devices installed in the door, such as lock cylinders, NFC readers, electronic locks, electric strike plates, magnetic locks, etc. For more information about the iLOQ 5 Series Online System, please visit support.iloq.com.



WARNING! The door module is intended to be installed in dry indoor conditions.

2.2 Before installation

iLOQ does not sell or provide products that require installation by an official electrician. Installation should still be performed by a qualified installer to avoid personal injury and product damage. Before proceeding with installation, read and understand the **safety information** thoroughly.



Read these instructions carefully before installation. This information is to ensure your safety and the long lifetime of the installed products. After use, make sure that these instructions are passed on from the installer to the user.

2.3 Licenses

The iLOQ N501.1 Standalone Door Module has its own license and it does not require a separate online license. More detailed information on licenses is available in the iLOQ Partner Portal and in the iLOQ 5 Series product price list.

2.4 iLOQ N501.1 Standalone Door Module modem type

LARA modem R202 (designed mainly for operation in America on LTE and 3G networks) supporting the following LTE bands and frequencies:

- Band 12 (700 MHz)
- Band 5 (850 MHz)
- Band 4 (1700 MHz)
- Band 2 (1900 MHz)

3. Installation of the devices

3.1 Device dimensions

iLOQ N501.1 Standalone Door Module

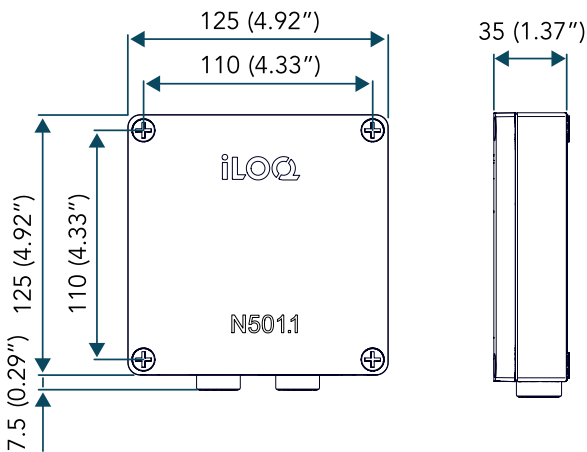

3.2 Overview of the iLOQ N501.1 Standalone Door Module

The iLOQ N501.1 Standalone Door Module is equipped with a 4G connection to the iLOQ Cloud. With the Standalone Door Module, remote or otherwise hard-to-wire door environments can be easily connected to be a part of the iLOQ Online system. This allows the administrator to remotely control locks and keys with the iLOQ Manager without the need to visit the installation site.

The iLOQ N501.1 is installed in a secure interior space. The iLOQ N501.1 is located near a door, and it controls the devices installed on the door environment, such as iLOQ C5 Lock Cylinders, iLOQ NFC Readers, electric locks, door automation, and so on. Essentially, the N501.1 Standalone Door Module is two things at the same time; a Net Bridge and a Door Module/Lock, thus enabling the device to operate independently.

The iLOQ N501.1 has an RS-485 reader bus for connecting iLOQ NFC Readers. The iLOQ N501.1 has two potential-free relays, which, based on the selected operation mode, can be controlled by placing a valid iLOQ Key to a connected iLOQ NFC Reader or C5 Cylinder, with group access codes or with direct calendar controls from the iLOQ Cloud. iLOQ HOME can also be used to remotely control the relays. Other information such as door status information can be collected via the iLOQ N501.1 inputs to the iLOQ Cloud. From a system point of view, the iLOQ N501.1 is a lock that needs to be programmed to operate as a lock. Initial programming is done via a connected iLOQ NFC Reader's NFC using the iLOQ Manager software and the iLOQ P55S.1 Programming key. Access rights, time limitations and other settings of the iLOQ N501.1, and the connected C5 Cylinders, can be remotely updated at any time.

3.3 Installing the iLOQ N501.1 Standalone Door Module



WARNING! The door module is intended for installation in dry indoor conditions. Do not remove the PCB from the enclosure because the antenna is fixed to the back wall of the enclosure.

1. Open the enclosure cover by opening the plastic fixing screws.
2. Use the fixing points at the bottom of the screw channel to attach the enclosure to the wall.

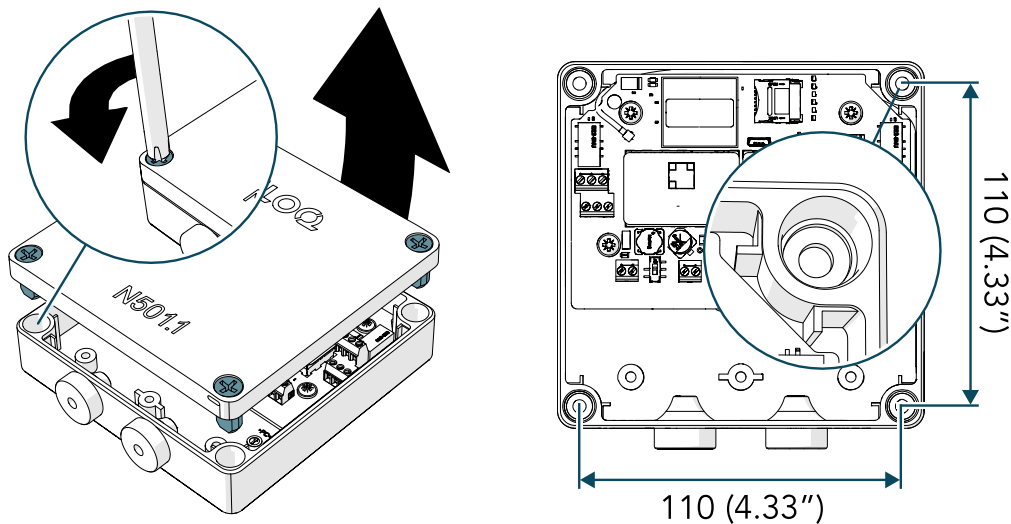

3. Close the enclosure cover with the plastic fixing screws, after finalizing the setup and programming.

4. Wiring the system



WARNING! Risk of a short circuit. Make sure that the wiring is performed properly with the power switched off and according to the instructions.



NOTE! Use twisted pair and shielded cables when possible. Recommended cable types and lengths can be found in the iLOQ 5 Series Online System Planning Guide.

4.1 N501.1 Connection points and additional information

- On / Standby: Power On/Off
- Setup / Operating: Setup state is used to trigger the Setup process
- 12-24V/max 60W DC: Power supply connection
- Power out: Voltage output, the values are determined by the used power supply
- Reader RS-485: For connecting an iLOQ NFC Reader
- L1 + L-GND: C5S cylinder connection
- IN1 + COM: Opening button
- IN2 + COM: Door status information
- EXT + COM: Input for conditional access right
- K1 relay: Reader, PIN, calendar and code access group opening
- K2 relay: Calendar and code access group opening

4.2 Example of wiring for the iLOQ N501.1 Standalone Door Module

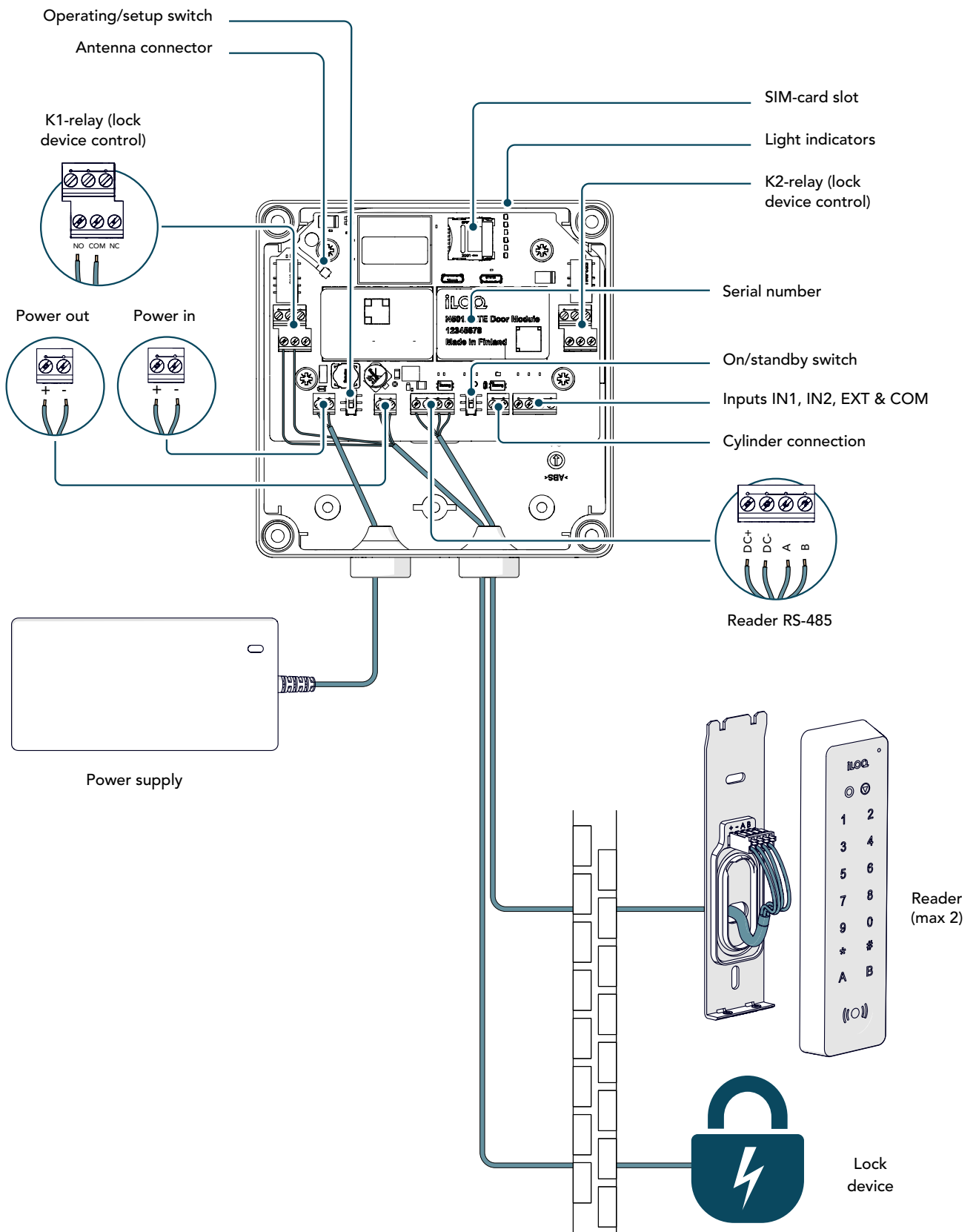

5. Deployment

Install and connect the iLOQ N501.1 Standalone Door Module and its bus devices according to chapters 3 and 4. All devices must be successfully connected before performing the setup.

5.1 Setup

This chapter describes how to prepare the iLOQ N501.1 Standalone Door Module and connected bus devices for programming. The setup is purely about finding the physical devices in the RS-485 bus and has nothing to do with the programming of the iLOQ Online devices (see chapter Programming). The setup has to be performed whenever sub-devices are added to/deleted from the bus. During the setup process, the bus is reset, all the connected devices are searched for and, if found, given a new bus address. In the case of N501.1 Standalone Door Modules, the bus device can be any iLOQ NFC Reader and optionally C5S.x cylinders.



NOTE! The setup has to be performed whenever bus devices are added to/deleted from the bus.

1. Modify the following settings:

- Switch mode to SETUP
- Switch power to ON
- Wait 5 seconds
- Switch mode to OPERATING

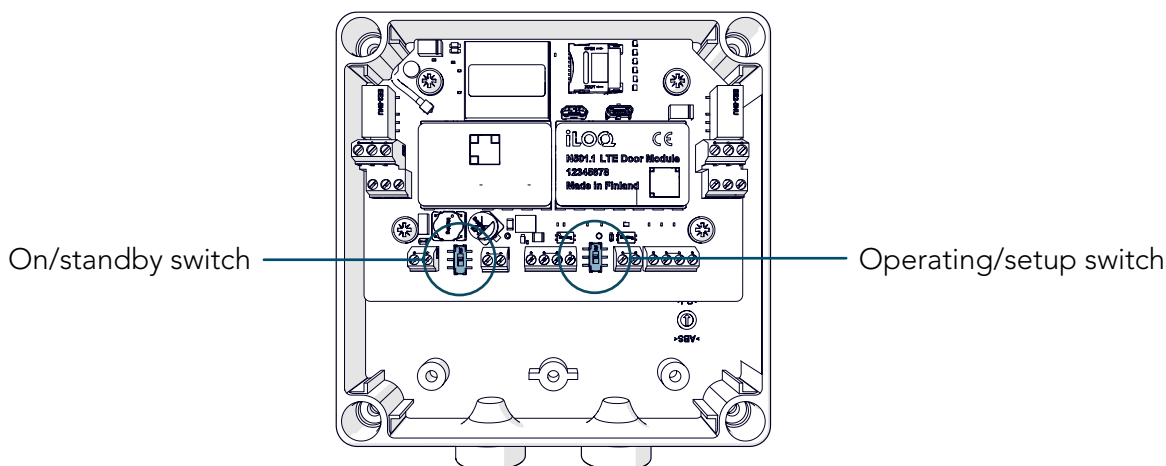

- Make sure that the light indicators on the iLOQ N501.1 Standalone Door Module are as depicted in the following picture.
This indicates that the bus configuration has been saved successfully.

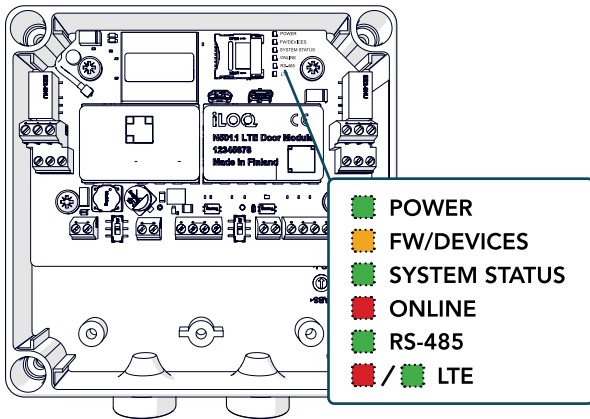

NOTE! If the light indicators are not as they are shown in the picture, do not start the programming. Repeat the setup and wait until the light indicators are correct.

- Make sure that the status light is amber on all connected NFC readers.

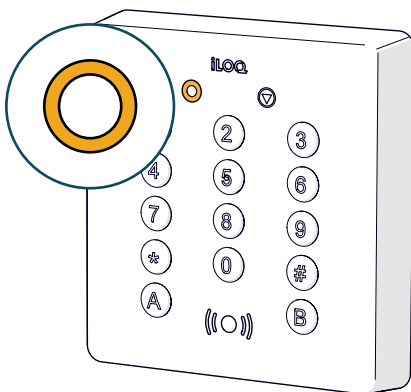

<ul style="list-style-type: none"> Amber light 	Indicates that the reader has connection to the door module.
<ul style="list-style-type: none"> Red light 	Indicates that there is no connection to the door module or the setup has not been done.
<ul style="list-style-type: none"> Green light 	Indicates that the door module is programmed and connection to server is OK.
<ul style="list-style-type: none"> Blue light 	Indicates that the reader firmware is being updated. Don't turn off the power!

5.2 Adding a network module to the iLOQ Manager

Before the iLOQ N501.1 Standalone Door Module programming can be done it has to be added to the system using the iLOQ Manager. From the system point of view, the N501.1 Door Module acts as a network module and as a lock. All actions are done in one go by using the "Add network module" Wizard. More detailed instructions can be found from the iLOQ Manager and iLOQ support portal at support.iloq.com.

1. Select "Add network module" > the Wizard will open.
2. Follow the Wizard to add network module details.
After adding the network module, the Wizard will automatically jump to adding a Lock.
3. Transfer the programming task to the iLOQ P55S.1 Programming Key.
4. Disconnect the iLOQ P55S.1 Programming Key from the USB cable/programming adapter.

The P55S.1 Programming Key is now ready to be used to program the devices (see chapter "Programming").



NOTE! When entering the general details of the network module, use a descriptive name. For example, use a name that indicates the location of the module.

5.3 Programming

This chapter describes how to complete the device configuration of the iLOQ N501.1 Standalone Door Module by programming it. To continue to programming, the previous steps have to be successfully done and the iLOQ N501.1 power has to be turned ON. Make sure that the devices are still connected, the setup has been completed and the iLOQ P55S.1 Programming Key has the programming packet as described in the chapter "Adding a network module in the iLOQ Manager".

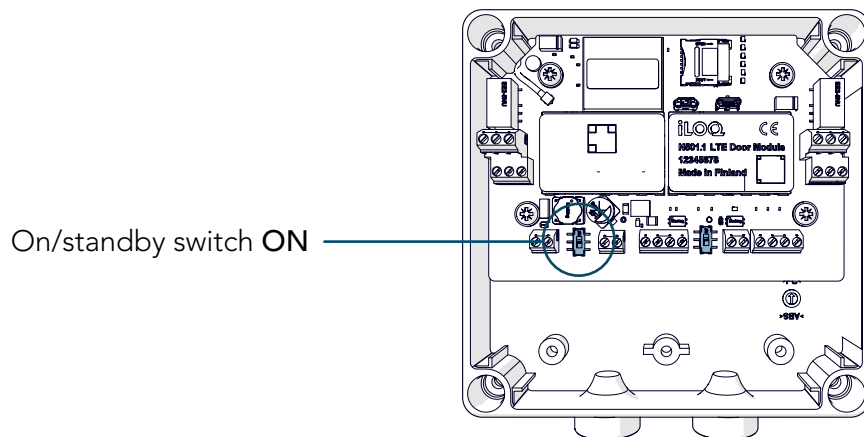

1. Start the deployment programming by disconnecting the P55S.1 Programming Key from the PC and place it on the NFC reader.
 - At the start of the deployment programming, the reader's progress indicator and the programming key's LED light are both amber.
 - It takes approximately 5–10 seconds to upload the programming package from the Programming Key to the iLOQ N501.1 via the iLOQ NFC Reader. When the programming is ready, the Reader will beep and a green light will appear. If a red light is shown together with an error beep - try again.

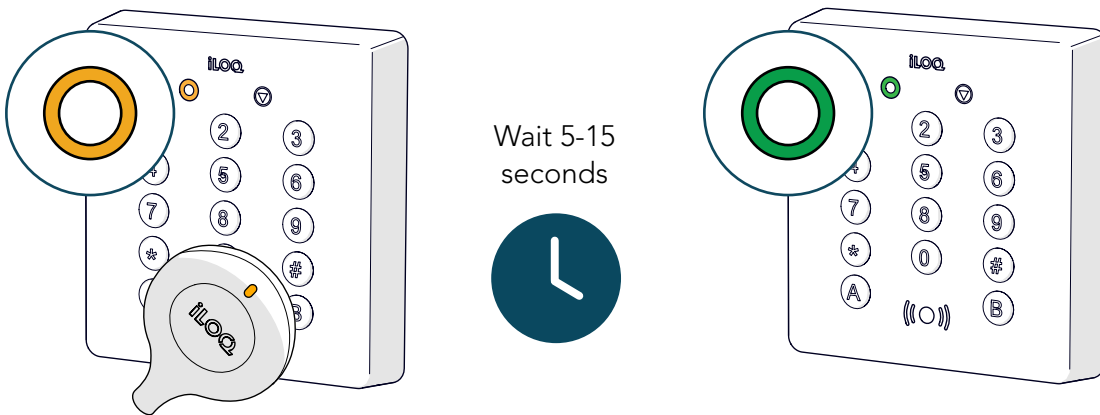

- At the end of the deployment programming, the iLOQ N501.1 light indicators **POWER**, **FW/DEVICES**, **SYSTEM STATUS**, **ONLINE** and **RS-485** lights are green. The **LTE** light does not indicate any essential information at this point.
2. Make sure that the status light is green on all connected NFC readers. If the light indicators are green in all door modules and the status light is green on all connected NFC readers, the deployment has been completed.

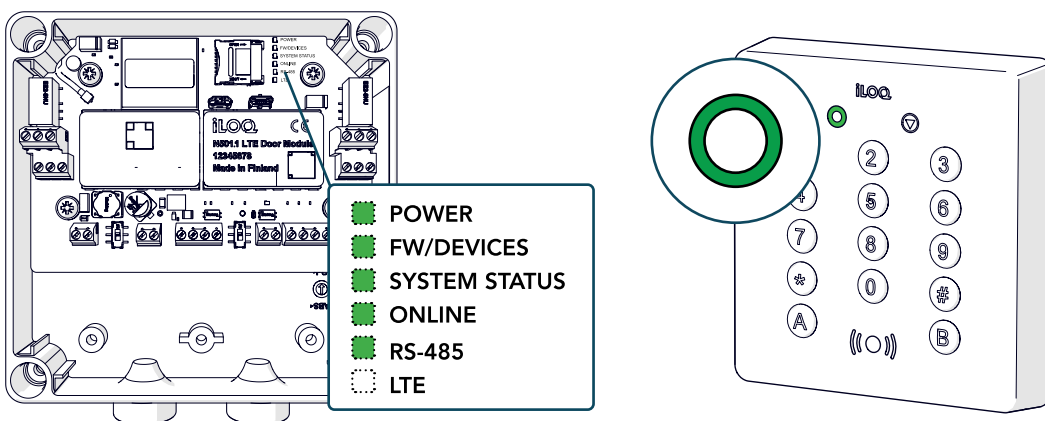

3. Switch the iLOQ N501.1 On/Standby switch to **STANDBY** and then back **ON**.
4. Wait until all of the iLOQ N501.1 light indicators are green.
If they are all green, the deployment has been completed and the devices are ready for use.

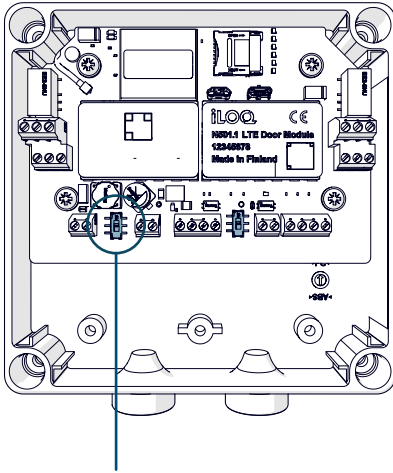

On/standby switch ON

Wait 5-15 seconds

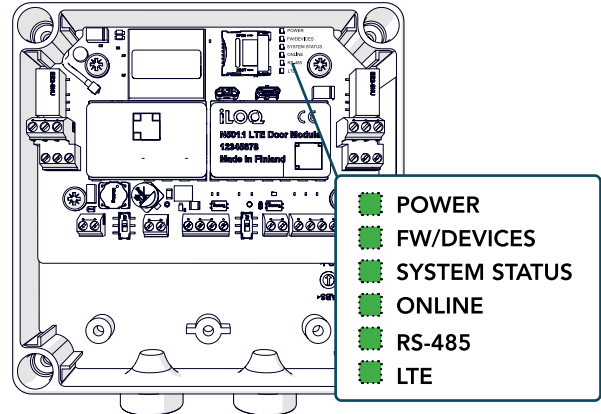

6. iLOQ Manager

This chapter describes the most important features and settings that must be performed for iLOQ Online devices, both during the deployment and when maintaining the system. This manual **does not** cover calendar control related settings, such as:

- Calendar controllable doors
- Monitored doors
- Calendar
- Direct control calendar
- Code-access groups
- PIN-code calendar

More detailed instructions can be found at support.iloq.com.

6.1 Editing the settings of a Network Module (Net Bridge)

Basic Network settings:

1. Browse Network Modules.
2. Right click a Network Module and choose "Modify settings of device".
 - DHCP / Fixed IP selection
 - Network module User selection and password change

Relay/Input:

1. Browse Network Modules.
2. Right click a Network Module and choose "Edit relay settings".
3. Select which Relays are calendar controllable and edit the names of them
4. Select which Inputs are used for monitoring function

6.2 Editing the settings of an iLOQ N501.1 Lock (Door Module)

Relay mode and Relay impulse time:

1. Browse Locks.
2. Right click a Lock and choose "Edit key switch relay settings".
3. Edit the length of time that the Relay remains active after a valid key is used.

Access rights:

1. Browse Locks.
2. Right click a Lock and choose "Edit access rights".
3. Choose which access rights are needed to open the lock.

6.3 Typical things to look at in the iLOQ Manager

Report date:

1. Browse Network Modules.
2. Right click a Network Module and choose "Properties".
3. Choose the tab "Networked".
 - This can be used to check if the device has been online or not
 - Indicates the last date/time when the N500/1 Net Bridge has made a connection with the iLOQ Cloud, typically this is done every 15 minutes

-Properties of the selected network module					
Basic information	Locks	Networked	Remote load station queue	Calendars	Devices
-Latest reported data from network module					
Network module	N501.1 Espoo office				
IP and port	193.65.104.122 0				
Mac-address	89882390000021848430 11,4				
Report date	19.1.2023 13.55.40				
Programmer version	83				
Software version	1.2.163.279				
Calendar updated	10.1.2023 13.30.11				

Software version:

1. Browse Network Modules.
2. Right click a Network Module and choose "Properties".
3. Choose the tab "Networked".
 - From the row "Software version" you can check whether the devices have successfully installed the latest software

Signal strength:

- For the device iLOQ N501.1 Standalone Door Module, the signal strength of the data connection can be checked from the two last digits after the Mac-address.
- The first digit: the higher the better, the second digit: the lower the better

Mac-address	89882390000021848430	11,4
-------------	----------------------	------

Pink rows:

- A row highlighted in pink in both the Browse-Network-Modules and Browse-Locks view indicates that a device is missing its iLOQ Cloud connection

Send to:

1. Browse Network Modules
2. Right click a Network Module and choose "Send to".
 - In this window, multiple tasks can be performed manually by commanding the N500/1 Net Bridge

Door audit trail:

1. Browse Locks.
2. Right click a Lock and choose "Properties".
3. Choose the tab "Door audit trail"
→ In this window, the calendar controls, code and key accesses can be seen

Event log:

- The system event log gives information about network modules that have been rebooted

6.4 Updates

iLOQ releases Online device software updates 2-4 times per year. Updates can include new features, bug fixes and security updates. The N500/N501.1 Net Bridges start to download the update immediately after it is made available to the iLOQ Cloud.

The installation time of the update is defined by the admin of the system in the locking system setting of the iLOQ Manager. The default update time is 02:00 am based on the locking system time zone. Admins can also choose to manually update the Online devices from the network module view as soon as the update is available.

In the iLOQ Manager:

1. Browse network modules.
2. Right click a network module.
3. Choose "Send to network module".
4. Click "Request to update firmware".

After the N500/1 Net Bridge has downloaded the update installation packages, it will first update itself and then all the connected bus devices. During the update, the systems will reboot automatically. The firmware update is visually indicated with blue lights on the Reader and a blinking orange light on Net Bridge. During the firmware update, do not disconnect the network connection or the power supply from the devices.

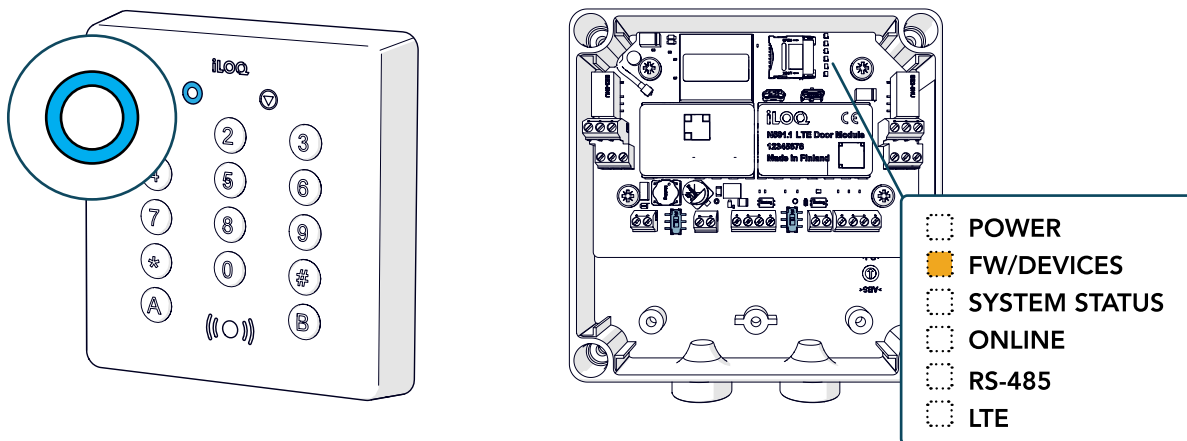

6.5 Typical cases in the field



NOTE! If the device is online when the task is ordered in the iLOQ Manager, the task will be done via the iLOQ Cloud connection right after ordering the task.

Replacing a broken iLOQ N501.1 Standalone Door Module with a new one (products needed: iLOQ N501.1):

1. Connect the new iLOQ N501.1 and the old NFC Reader as per the wiring instructions.
2. Perform the setup process (see chapter "Setting up the iLOQ N501.1 Standalone Door Module for programming").
3. Add a new network module in the iLOQ Manager by following the Wizard.
4. Program the new N501.1 with the P55S.1 Programming Key.

Replacing a broken NFC Reader N504/5/6 with a new one:

1. Replace the broken NFC Reader with a new one.
2. Perform the setup process (see chapter "Setting up the iLOQ N501.1 Standalone Door Module for programming").

Adding an iLOQ N501.1 as a lock after programming an iLOQ N501.1 as a network module has failed:

- If, for example, adding a network module has failed, you might be in a situation when you have an iLOQ N501.1 network module in the system, but the iLOQ N501.1 lock is missing
1. Add Lock – Choose Lock cylinder -type N501.1 – Select N501.1 Network Module from the list – At the end, Transfer the programming packet to the P55S.1 Programming Key.
 2. Place the P55S.1 Programming Key on the Door/Wall reader.

Deleting a network module:

1. Browse Network Modules.
2. Right click Network Module.
3. Delete the Network Module.
4. Transfer the task to the P55S.1 Programming Key.
5. Place the P55S.1 Programming Key on the connected iLOQ NFC Reader.

Password reset:

- You have accidentally changed the password of the Online user and all the Online devices using that are offline
1. Browse Network Modules > Right click a Network Module and choose "Modify settings of device".
 2. Follow the Wizard > Enter the correct password for the Online user when asked to.
 3. Order and Transfer the task to the P55S.1 Programming Key.
 4. Place the P55S.1 Programming Key on the NFC Reader.

7. LED functions on the iLOQ NFC Reader

Connection status

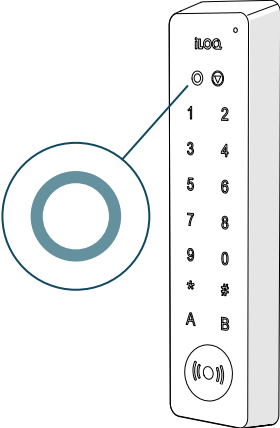
	<ul style="list-style-type: none"> • Amber light 	Connection to the door module is OK, which means that the cabling is OK and the setup is OK / iLOQ Cloud connection is lost (connection to the internet)
	<ul style="list-style-type: none"> • Red light 	Indicates that there is no connection to the door module or setup not done
	<ul style="list-style-type: none"> • Green light 	Indicates that the door module is programmed and connection to the server is OK
	<ul style="list-style-type: none"> • Blue blinking 	Indicates that the reader firmware is being updated Don't turn off the power!
	<ul style="list-style-type: none"> • Keypad blinking white 	Key PIN code is required

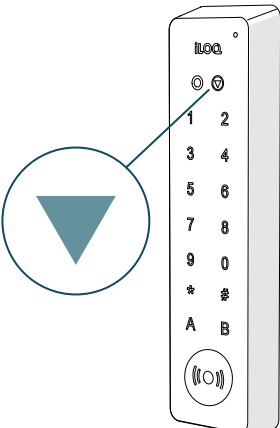

Key communication status

	<ul style="list-style-type: none"> • Amber light 	Key communication has started
	<ul style="list-style-type: none"> • Red light 	The key did not have a valid access right or the key communication failed
	<ul style="list-style-type: none"> • Green light 	Key communication was successful and the Key had a valid access right
	<ul style="list-style-type: none"> • Purple light 	A Phone key was presented
	<ul style="list-style-type: none"> • Blue blinking 	Reader SW is being updated
	<ul style="list-style-type: none"> • Keypad blinking white 	Key PIN code is required

8. Replacement and disposal

If a product is defective, replace it with a new one using the installation instructions. If you are not sure how to replace or discard a certain product, contact the device manufacturer. Contact information can be found at support.iloq.com.

8.1 Disposal of decommissioned products

	<p>Never discard an electrical appliance in household waste. Follow local laws and regulations for safe and environmentally friendly product disposal.</p>
	<p>Before discarding products, bear in mind that most iLOQ products are reusable. All programmable products can be reset to factory settings, after which they can be reused in another system.</p>

Recycling instructions of decommissioned products are depicted below.

Decommissioned product	Sorting
<p>Decommissioned iLOQ fittings, mounting accessories and thumb turn knobs can be recycled as scrap metal.</p>	
<p>Decommissioned iLOQ products containing electronics and circuit boards, such as iLOQ Cylinders, iLOQ Keys, net bridges, door modules, key and NFC readers, and relay cards, must be recycled at an electrical and electronic equipment collection point.</p>	
<p>iLOQ products containing batteries and accumulators, such as key fobs, programming keys and clock circuits, should be recycled at a regional collection point for batteries and small accumulators.</p>	
<p>Most iLOQ packaging materials are suitable for cardboard and plastic recycling.</p>	

9. Compliance

FCC

This device complies with part 15 of the FCC Rules. Operation is subject to the following two conditions: (1) This device may not cause harmful interference, and (2) this device must accept any interference received, including interference that may cause undesired operation.

NOTE: This equipment has been tested and found to comply with the limits for a Class B digital device, pursuant to part 15 of the FCC Rules. These limits are designed to provide reasonable protection against harmful interference in a residential installation. This equipment generates, uses and can radiate radio frequency energy and, if not installed and used in accordance with the instructions, may cause harmful interference to radio communications. However, there is no guarantee that interference will not occur in a particular installation. If this equipment does cause harmful interference to radio or television reception, which can be determined by turning the equipment off and on, the user is encouraged to try to correct the interference by one or more of the following measures:

- Reorient or relocate the receiving antenna.
- Increase the separation between the equipment and receiver.
- Connect the equipment into an outlet on a circuit different from that to which the receiver is connected.
- Consult the dealer or an experienced radio/TV technician for help.

Changes / modifications not approved by the responsible party could void the user's authority to operate the equipment.

ISED

This device contains license-exempt transmitter(s)/receiver(s) that comply with Innovation, Science and Economic Development Canada's license-exempt RSS(s)

Operation is subject to the following two conditions:

1. This device may not cause harmful interference.
2. This device must accept any interference received, including interference that may cause undesired operation of the device.

L'émetteur/récepteur exempt de licence contenu dans le présent appareil est conforme aux CNR d'Innovation, Sciences et Développement économique Canada applicables aux appareils radio exempts de licence. L'exploitation est autorisée aux deux conditions suivantes:

1. L'appareil ne doit pas produire de brouillage;
2. L'appareil doit accepter tout brouillage radioélectrique subi, même si le brouillage est susceptible d'en compromettre le fonctionnement.



iLOQ 5 Series

iLOQ N501.1 Standalone Door Module

Installation and deployment

iLOQ

support.iloq.com

Elektroniikkatie 10

90590 Oulu

Finland