

H5S5.1.27.HC Padlock, shackle 15/27 mm

System-level description

iLOQ S5 locking system offers advanced security and convenient access management for master-key locking environments.

The iLOQ S5 padlocks enable usage of the iLOQ S5 locking system for securing remote objects and locations. The self-powered iLOQ padlocks are available in different body and shackle sizes. The iLOQ padlock records audit trails of key usage and enables flexible access management for each key and each padlock. The security level is kept high and security gaps caused by lost keys can be eliminated completely without costly changes of locks and keys. The iLOQ D2D network allows users to update lock-related access rights, time limitations and lists of lost keys as well as collect log event data from the locks.

The product should not be modified in any way except in accordance with those modifications described in the instructions.

Feature summary

- Programmable electromechanic padlock for iLOQ S5 locking system
- Self-powered: no batteries or external energy source required for the lock and key
- Lock acts as a part of the iLOQ D2D network
- All iLOQ S5 padlocks and iLOQ S5 keys are mechanically identical
- Secured using powerful encryption methods: 256-bit AES (Advanced Encryption Standard)
- Programmed using a PC and the iLOQ P55S.1 Programming Key
- Blocklist for individual lost keys
- Access group list for key accesses
- Firmware updateable
-
- The product should not be modified in any way except in accordance with those modifications described in the instructions

Dimensional drawing

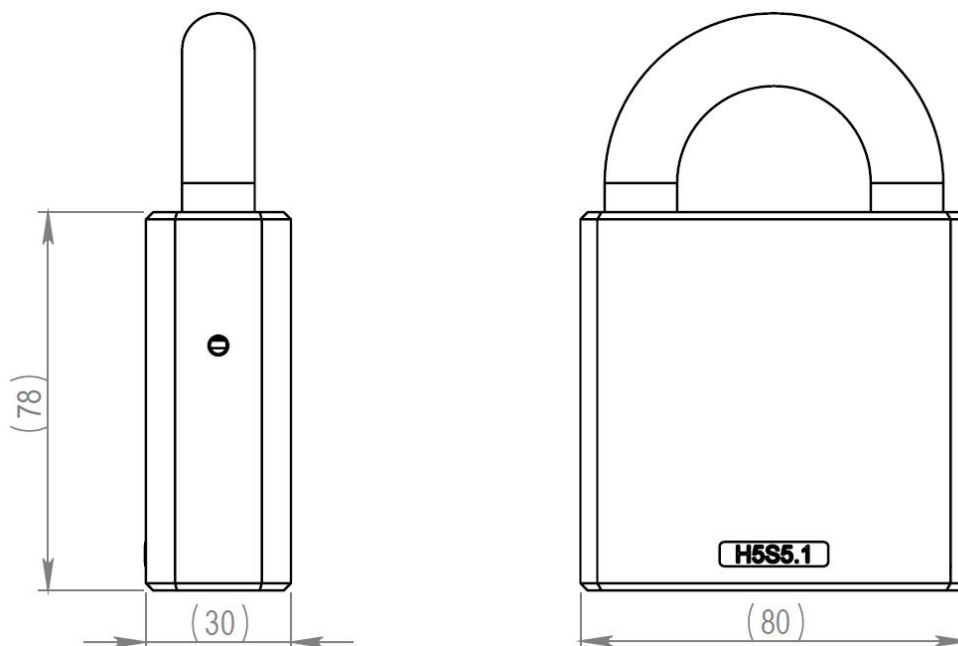

Memory capacity

Number of access rights	210
Number of blocklisted keys	500
Number of time slots	10
Size of event log	500

Technical data

Chain included	X
Ingress protection rating	IP21
Security grade	Grade 5
Real time clock battery lifetime	No batteries
Real time clock compatibility	Not compatible
Remote management with iLOQ Online products	X
Surface treatment	Polished chrome
Maximum temperature	80°C
Maximum temperature	176°F
Minimum temperature	-40°C
Minimum temperature	-40°F
Usage environment	Outdoor

Certificates

Attack resistance (EN 16864:2017)	Class 5
Category of use (EN 16864:2017)	Class 1
Corrosion resistance (EN 16864:2017)	Class 3
Durability (EN 16864:2017)	Class 1
Electronic key related security (EN 16864:2017)	Class D
Environmental resistance (EN 16864:2017)	Class 4
Mechanical key related security (EN 16864:2017)	Class 0
System management (EN 16864:2017)	Class 2