

## K55S.1 Key Fob

---

### System-level description

The patented, award winning iLOQ 5 Series locking system offers advanced security and convenient access sharing features for master key locking environments.

The iLOQ K55S.1 Key Fob is used for operating digital lock cylinders in the iLOQ 5 Series locking system for users without a compatible NFC-enabled smartphone for unlocking. The Key Fob supplies the required operating power to the lock over the NFC field during opening, thus the locks do not need their own power supply.

The Key Fob is equipped with an internal accumulator. One charging of the internal accumulator will last several months. When the device needs recharging it will inform users weeks before recharging is necessary. This feature helps users avoid situations where energy levels are too low for opening locks at sites. The Key Fob can be charged with a commonly used USB B-type cable that is delivered with the Key Fob. The Key Fob is designed for harsh environments and climates, while remaining water-resistant and dustproof.

The Key Fob can carry and blocklisting tasks.

---

### Feature summary

- Rechargeable digital key for iLOQ 5 Series locking system
- Secured using AES-256 encryption
- Programmed on iLOQ Manager – software with system specific Programming key
- Re-programming through Programming key
- Each key has a unique identifier and can be individually blocklisted
- Supports validity time and versatile time restrictions
- Receives and transfers blocklist from/to locks when used offline
- Sturdy, sealed structure for harsh environments with led status indication
- Can be personalized with color pin
- Laser stamped one letter and four-digit random number

## Dimensional drawing

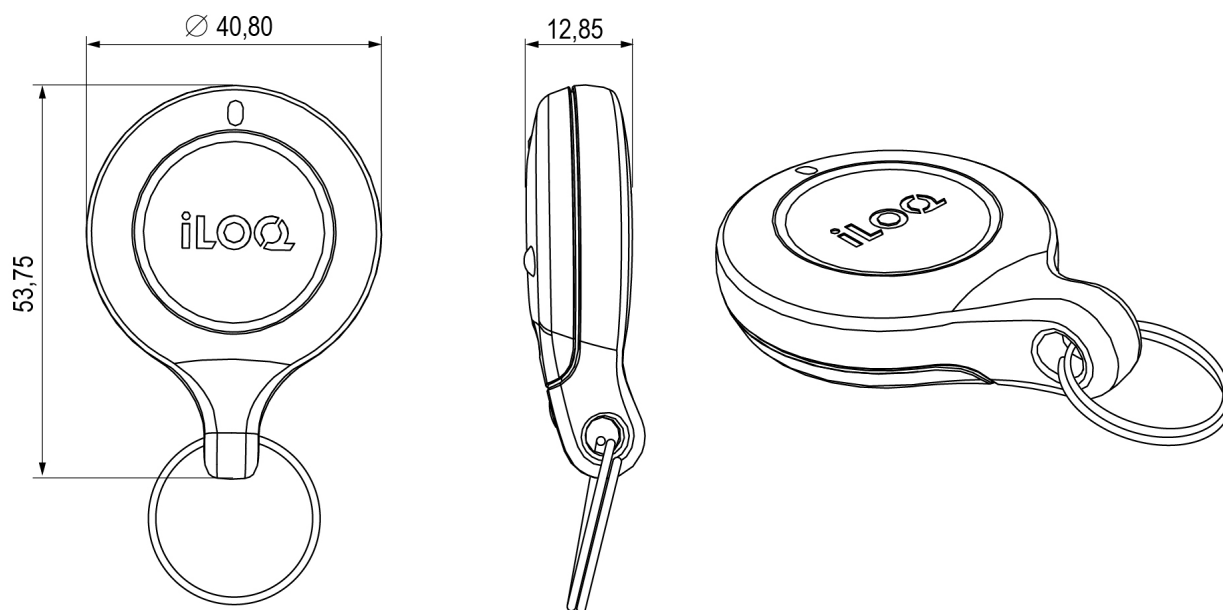

## Memory capacity

Number of access rights.....	210
Number of blocklisted keys.....	50
Number of time slots.....	9
Size of key event log.....	200

## Technical data

Changeable color marker.....	✓
Maximum charging temperature.....	113°F
Minimum charging temperature.....	32°F
Color.....	Oceanic blue
Ingress protection rating.....	IP57
NFC.....	✓
Rechargeable battery lifetime per charge.....	5,000 openings / 1 year standby-time
Maximum temperature.....	140°F
Minimum temperature.....	-4°F

## Certificates

Attack resistance (EN 15684:2013-01).....	Class 2
Category of use (EN 15684:2013-01).....	Class 1
Durability (EN 15684:2013-01).....	Grade 6
Electronic key related security (EN 15684:2013-01).....	Class F
Environmental resistance (EN 15684:2013-01).....	Class 4
Fire/smoke resistance (EN 15684:2013-01).....	Class 0
Mechanical key related security (EN 15684:2013-01).....	Grade A
System management (EN 15684:2013-01).....	Grade 3
Other certificates.....	FCC Part 15C FCC Part 15B (ICES-003) FCC Part 15.255 (ISED RSS-210) ICES 003. issue 7:2020 - class B