

Z50S.11X.A.26.T Cylindrical Leverset

System-level description

The patented, award winning iLOQ S50 locking system offers advanced security and convenient access sharing capabilities for master-key locking environments.

The iLOQ Z50S cylindrical leversets harvest electricity wirelessly from NFC field, which enables using phone not only as a key but also as a power source thus the lock is completely battery free. As no batteries are required, the locks are maintenance free and environmentally friendly green solution that eliminates work, costs, waste and harm associated with battery powered solutions.

The lock doesn't have a keyway due to the contactless NFC operation. It is designed to withstand harsh environments where the locks are exposed to dust, moisture and varying temperature conditions ranging from extremely cold to hot weather.

The phone as a key enables flexible access sharing with time restrictions and audit trail reporting over the air. The security level is kept high and security gaps caused by lost key can be eliminated completely without costly change of locks and keys.

Feature summary

- NFC-powered: No batteries are required for the cylinder
- Opened with NFC enabled iPhone, Android phone and K55S Key Fob
- Secured using powerful AES256 encryption and mutual authentication
- Initial programming with PC and iLOQ P55S.1 Programming Token in connection to server
- Share and revoke access rights over the air
- Blocklist for lost key fobs
- Audit trail records with time stamp (can be configured on/off)
- Supports time restrictions
- Can be configured to require online opening authentication
- Can be re-programmed in the field with phone keys
- Firmware updateable
- Satin Chrome finish (26D)
- 1/4" Spacer ring set (26D) is available as an accessory for 1 3/8" thin doors (Product Code: AX50.Z.SP.26)

Dimensional drawing

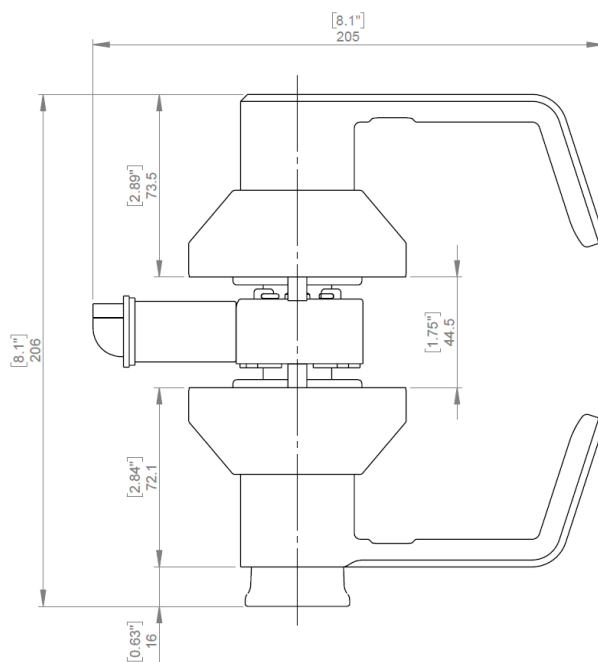

Memory capacity

Number of access rights	210
Number of blocklisted keys	500
Number of time slots	10
Size of event log	500

Technical data

Maximum temperature	80°C
Maximum temperature	176°F
Minimum temperature	-40°C
Minimum temperature	-40°F
Certificates	FCC
Certificates	ISED